

New - generation

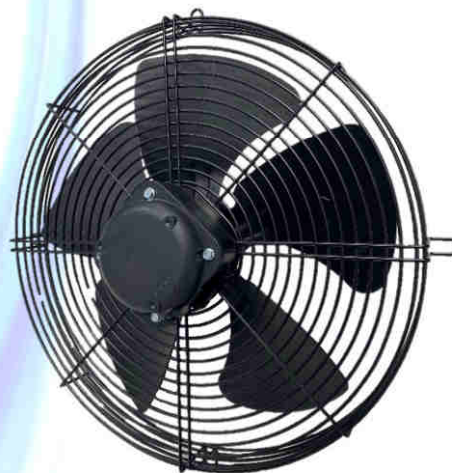

**ECM universal power supply:
from 100Vac to 240Vac**



UA = 1 speed – 1350 rpm
UD = 1 speed – 1350 rpm reverse on demand
UE = 1 speed – 1350 rpm reverse on start
UB = 2 speeds – 2100 or 1600 / 1350 rpm
UC = variable speed 2500 or 1600 ÷ 800 rpm electrically isolated
by external signal PWM or 0÷10Vdc.
and output open collector signal



MA-VIB SpA

Via Castel Rozzone, 15 - 24050 Lurano (BG) – ITALY
Tel. +39.029547403 – Fax +39.029549825

Internet Web Site: www.mavib.com

Sales Office: Italy = ita@mavib.com Export = expo@mavib.com



100V-240V ECM fan 08-15-21

with ring & impeller $\varnothing 154 \div \varnothing 254\text{mm}$

Serie S UB-UC

Air direction

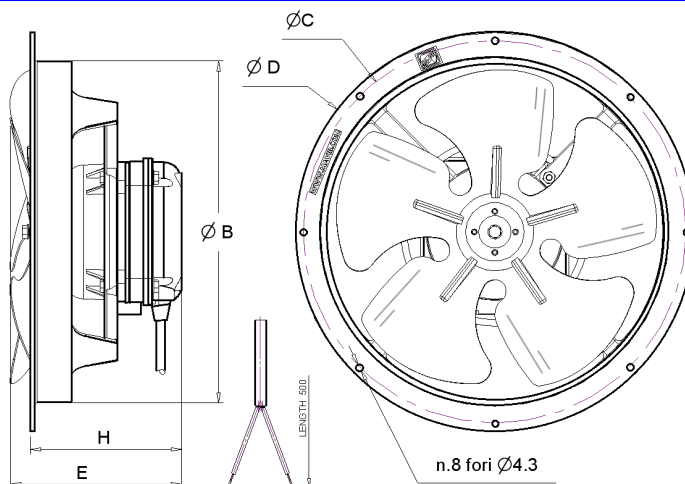
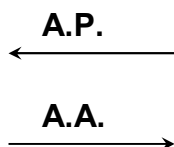

Electronic Commutated Motor 08 / 15 / 21 universal power supply 100-240 V – 50/60Hz

Operation mode	S1	IP protection	44 (on demand 55)	Standard of ref.
Mounting position	All	Marking	CE + (*)	EN 60335-1/A15/2-24/2-89(*) Gas IIA
Motor bearing	Ball	Ambient temp.	-40°C ÷ +50°C	60034-1(REM) 60529(IP) 60079-15(*)
Motor protection	Electronically (1)	Max. intake air	+ 50°C	(*) II 3G Ex nA IIA T6
Locked rotor protec.	Yes	Max. °C storage	-40°C ÷ +80°C	2006/42/CE(Mac) 2014/35/UE(Low V.)
Insulation	B	Expect. life Ball Bear.	Over 60.000 h	2014/30/UE(EMC) 2015/863(RoHS3)

(1) Safety protection automatically reduces rpm if exceed W.in limit, reached min. rpm fan stop/restart 3 time and stop working after safe try time

on demand different rpm are available

Serie S ECM 100V-240V - 50/60Hz universal power supply

CODE	Lable data				Impeller			Dimensions				
	A.	W.in free air	W.in Max. Pa	Prot.	UB 2 speed (2)	UC PWM/0-10 (2)	code	A	B	C	D	E ^{±1,5}
S08UB... S08UC...	0,16	6	14	Electr.	1800-1350 rpm	2500÷800 rpm	EL.5.154.27AA	175	190	200	98	91
					1800-1350 rpm	2000÷800 rpm	EL.5.172.27AA(*)	190	208	222	99	87
					1600-1350 rpm	1800÷800 rpm	LC.5.200.28AA	215	236	246	99	93
					1600-1350 rpm	1600÷800 rpm	EL.5.230.23AA	250	266	276	100	91
S15UB... S15UC...	0,26	18	24	Electr.	2100-1500 rpm	2100÷800 rpm	LC.5.200.34AA	215	236	246	98	93
					1600-1350 rpm	1600÷800 rpm	EL.5.230.27AA	250	266	276	102	91
					1600-1350 rpm	1600÷800 rpm	EL.5.254.19AA(*)	280	290	300	103	91
S21UB... S21UC...	0,58	23	55	Electr.	1600-1350 rpm	1800÷800 rpm	EL.5.230.31AA	250	266	276	123	91
					1600-1350 rpm	1600÷800 rpm	LC.5.254.34AA(*)	280	290	300	129	108
					1350-1000 rpm	1350÷800 rpm	EL.5.300.27AA(*)	310	344	356	137	108

(*) only metal ring "C.."

(2) see on Performance curves, for combined impeller relative W.in min. & max.

On demand are available version **UA** = 1 speed 1350rpm and the same in variant **UD** reverse on demand or in variant **UE** reverse on start

100V-240V ECM fan 08-15-21

with fan guard & impeller $\varnothing 154 \div \varnothing 254\text{mm}$

Serie R UB-UC

Air direction

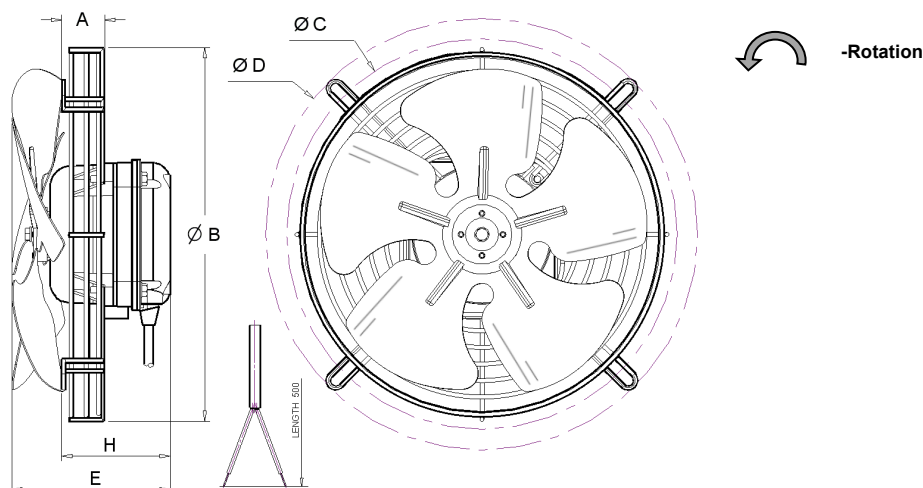
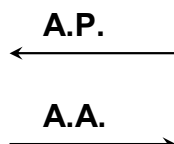

Electronic Commutated Motor 08 / 15 / 21 universal power supply 100-240 V – 50/60Hz

Operation mode	S1	IP protection	44 (on demand 55)	Standard of ref.
Mounting position	All	Marking	CE + (*)	EN 60335-1/A15/2-24/2-89(*) Gas IIA
Motor bearing	Ball	Ambient temp.	-40°C ÷ +50°C	60034-1(REM) 60529(IP) 60079-15(*)
Motor protection	Electronically (1)	Max. intake air	+ 50°C	(*) II 3G Ex nA IIA T6
Locked rotor protec.	Yes	Max. °C storage	-40°C ÷ +80°C	2006/42/CE(Mac) 2014/35/UE(Low V.)
Insulation	B	Expect. life Ball Bear.	Over 60.000 h	2014/30/UE(EMC) 2015/863(RoHS3)

(1) Safety protection automatically reduces rpm if exceed W.in limit, reached min. rpm fan stop/restart 3 time and stop working after safe try time

on demand different rpm are available

Serie R ECM 100V-240V - 50/60Hz universal power supply

CODE	Lable data				Impeller			Dimensions					
	A.	W.in free air	W.in Max. Pa	Prot.	UB 2 speed (2)	UC PVM/0-10 (2)	code	A	B	C	D	E ^{±1.5}	H
R08UB... R08UC...	0,16	6	14	Electr.	1800-1350 rpm	2000+800 rpm	EL.5.172.27AA	26	192	208	226	99	66
					1600-1350 rpm	1800+800 rpm	LC.5.200.28AA	26	228	236	261	99	66
					1600-1350 rpm	1600+800 rpm	EL.5.230.23AA	26	252	280	295	100	66
R15UB... R15UC...	0,26	18	24	Electr.	2100-1500 rpm	2100+800 rpm	LC.5.200.34AA	26	228	236	261	98	66
					1600-1350 rpm	1600+800 rpm	EL.5.230.27AA	26	252	280	295	102	66
					1600-1350 rpm	1600+800 rpm	EL.5.254.19AA	26	271	289	309	103	66
R21UB... R21UC...	0,58	23	55	Electr.	1600-1350 rpm	1800+800 rpm	EL.5.230.31AA	26	252	280	295	123	81
					1600-1350 rpm	1600+800 rpm	LC.5.254.34AA	26	271	289	309	129	80
					1350-1000 rpm	1350+800 rpm	EL.5.300.27AA	47	346	365	390	137	104
					1350-1000 rpm	1350+800 rpm	EL.5.315.27AA	47	346	365	390	139	104
					1350-1000 rpm	1350+800 rpm	EL.5.350.23AA	53	388	420	438	128	110

(2) see on Performance curves, for combined impeller relative W.in min. & max.

On demand are available version **UA** = 1 speed 1350rpm and the same in variant **UD** reverse on demand or in variant **UE** reverse on start

100V-240V ECM fan 08-15-21

with bracket & impeller

Serie E UB-UC

Air direction

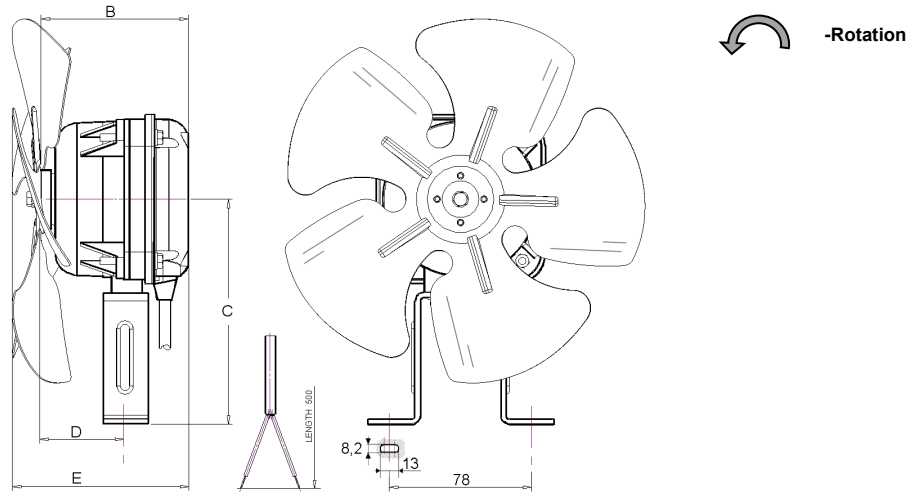
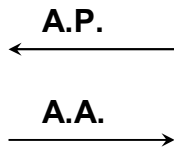

Electronic Commutated Motor 08 / 15 / 21 universal power supply 100-240 V – 50/60Hz

Operation mode	S1	IP protection	44 (on demand 55)	Standard of ref.
Mounting position	All	Marking	CE + (*)	EN 60335-1/A15/2-24/2-89(*) Gas IIA
Motor bearing	Ball	Ambient temp.	-40°C ÷ +50°C	60034-1(REM) 60529(IP) 60079-15(*)
Motor protection	Electronically (1)	Max. intake air	+ 50°C	(*) II 3G Ex nA IIA T6
Locked rotor protec.	Yes	Max. °C storage	-40°C ÷ +80°C	2006/42/CE(Mac) 2014/35/UE(Low V.)
Insulation	B	Expect. life Ball Bear.	Over 60.000 h	2014/30/UE(EMC) 2015/863(RoHS3)

(1) Safety protection automatically reduces rpm if exceed W.in limit, reached min. rpm fan stop/restart 3 time and stop working after safe try time

on demand different rpm are available

Serie E ECM 100V-240V - 50/60Hz universal power supply

CODE	Lable data				Impeller			Dimensions					
	A.	W.in free air	W.in Max. Pa	Prot.	UB 2 speed (2)	UC PWM/0-10 (2)	code	A	B	C	D	E ^{±1,5}	H
E08UB... E08UC...	0,16	6	14	Electr.	1800-1350 rpm	2500+800 rpm	EL.5.154.27AA	80	90	46	98		
					1800-1350 rpm	2000+800 rpm	EL.5.172.27AA						
					1600-1350 rpm	1800+800 rpm	LC.5.200.28AA						
					1600-1350 rpm	1600+800 rpm	EL.5.230.23AA						
E15UB... E15UC...	0,26	18	24	Electr.	2100-1500 rpm	2100+800 rpm	LC.5.200.34AA	80	122	46	98		
					1600-1350 rpm	1600+800 rpm	EL.5.230.27AA						
					1600-1350 rpm	1600+800 rpm	EL.5.254.19AA						
E21UB... E21UC...	0,58	23	55	Electr.	1600-1350 rpm	1800+800 rpm	EL.5.230.31AA	100	134	48	123		
					1600-1350 rpm	1600+800 rpm	LC.5.254.34AA						
					1350-1000 rpm	1350+800 rpm	EL.5.300.27AA						

(2) see on Performance curves, for combined impeller relative W.in min. & max.

On demand are available version **UA** = 1 speed 1350rpm and the same in variant **UD** reverse on demand or in variant **UE** reverse on start

100V-240V ECM motors 08-15-21

multi fixing for impeller Ø 154 ÷ Ø 254mm

Serie EFCR UA

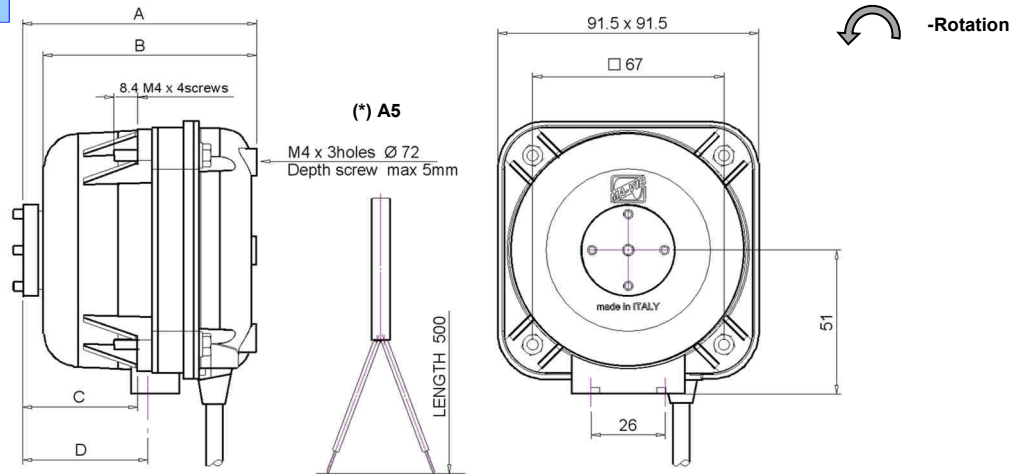

Electronic Commutated Motor 08 / 15 / 21 universal power supply 100-240 V – 50/60Hz

Operation mode	S1	IP protection	44 (on demand 55)	Standard of ref.
Mounting position	All	Marking	CE + (*)	EN 60335-1/A15/2-24/2-89(*) Gas IIA
Motor bearing	Ball	Ambient temp.	-40°C ÷ +50°C	60034-1(REM) 60529(IP) 60079-15(*)
Motor protection	Electronically (1)	Max. intake air	+ 50°C	(*) II 3G Ex nA IIA T6
Locked rotor protec.	Yes	Max. °C storage	-40°C ÷ +80°C	2006/42/CE(Mac) 2014/35/UE(Low V.)
Insulation	B	Expect. life Ball Bear.	Over 60.000 h	2014/30/UE(EMC) 2015/863(RoHS3)

(1) Safety protection automatically reduces rpm if exceed W.in limit, reached min. rpm fan stop/restart 3 time and stop working after safe try time

on demand different rpm are available

Serie EFCR 08/15/21 UA ECM 100V-240V - 50/60Hz universal power supply

CODE	Lable data						Dimensions				Impeller		W.in with impeller
	Speed	RPM 50/60Hz	A.	W.in free air	W.in Max. Pa	Prot.	A ^{±1.5}	B ^{±1.5}	C	D	Ø	incl. °	
EFCR08UA.A2/A5	1 Speed	1350	0,16	6	14	Electr.	80	73	40,5	44	154	19° + 31°	(2)
											172	19° + 31°	
											200	19° + 27°	
											230	19° + 23°	
EFCR15UA.A2/A5	1 Speed	1350	0,26	18	24	Electr.	80	73	40,5	44	200	27° + 34° (LC)	
											230	23° + 27°	
											254	19° + 28° (LC)	
EFCR21UA.A2/A5	1 Speed	1350	0,58	23	55	Electr.	100	90	43	46	230	27° + 31°	
											254	27° + 34° (LC)	
											300	19° + 27°	
											315	19° + 27°	
											350	19° + 23°	

(2) see on Performance curves, for combined impeller relative W.in min. & max.

On demand is available : **UD** reverse on demand / **UE** reverse on start / **UB** version 2 speeds as per Serie S / R / E

Aluminium impeller

5 blades

Serie EL.5 ...

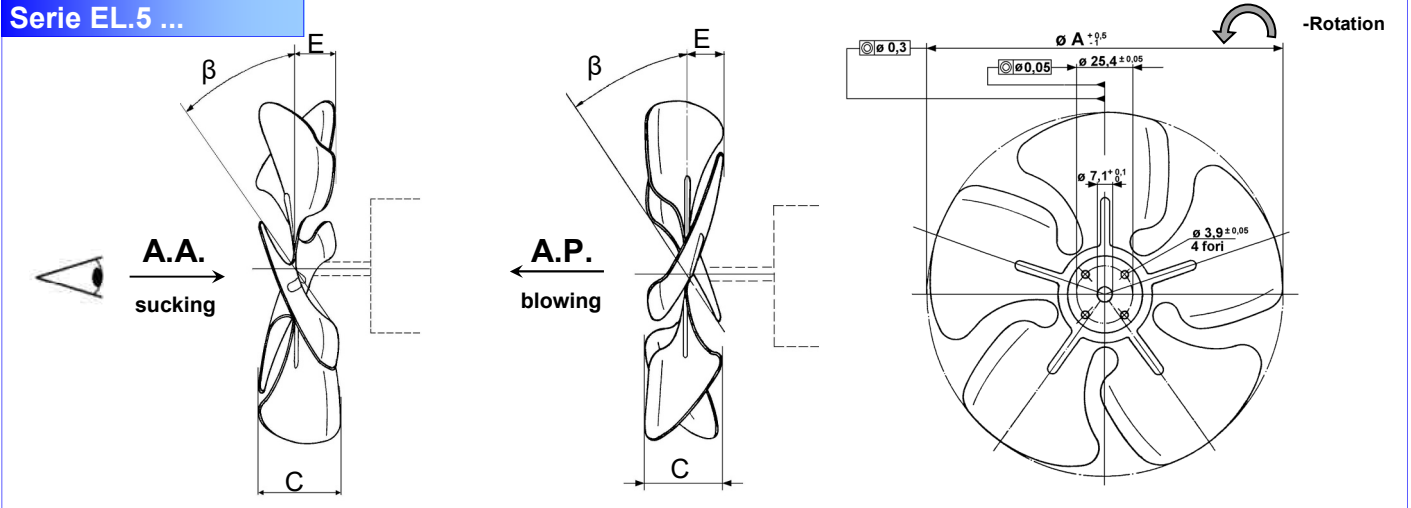

Serie EL.5 ...

CODE	Dimensions						Motors combination
	A	B	C ± 2mm		E ± 1.5mm		
	ø, mm	Incl, °	A.A.	A.P.	A.A.	A.P.	
EL . 5 . 154 . 19	154	19°	20	26	11	12	See each motor version
EL . 5 . 154 . 23	154	23°	25	30	12	12	
EL . 5 . 154 . 27	154	27°	29	35	12	16	
EL . 5 . 154 . 31	154	31°	32	41	12	20	
EL . 5 . 172 . 19	172	19°	27	26	12	15	
EL . 5 . 172 . 23	172	23°	31	31	14	17	
EL . 5 . 172 . 27	172	27°	36	36	16	16	
EL . 5 . 172 . 31	172	31°	38	41	18	20	
EL . 5 . 200 . 19	200	19°	31	32	15	16	
EL . 5 . 200 . 23	200	23°	35	36	17	17	
EL . 5 . 200 . 27	200	27°	42	43	19	18	
EL . 5 . 200 . 31	200	31°	45	49	22	24	
EL . 5 . 200 . 34	200	34°	-	51	-	26	
EL . 5 . 230 . 19	230	19°	31	37	20	14	
EL . 5 . 230 . 23	230	23°	41	40	21	24	
EL . 5 . 230 . 27	230	27°	47	47	25	26	
EL . 5 . 230 . 31	230	31°	54	52	30	24	
EL . 5 . 254 . 19	254	19°	34	39	20	17	
EL . 5 . 254 . 23	254	23°	45	45	21	24	
EL . 5 . 254 . 27	254	27°	53	52	27	27	
EL . 5 . 254 . 31	254	31°	61	58	34	27	
EL . 5 . 254 . 37	254	37°	-	70	-	28	
EL . 5 . 300 . 19	300	19°	43	42	25	19	
EL . 5 . 300 . 23	300	23°	50	54	22	24	
EL . 5 . 300 . 27	300	27°	61	59	23	26	
EL . 5 . 300 . 31	300	31°	-	67	-	33	
EL . 5 . 315 . 19	315	19°	51	-	25	-	
EL . 5 . 315 . 23	315	23°	61	-	29	-	
EL . 5 . 315 . 27	315	27°	71	-	32	-	
EL . 5 . 315 . 31	315	31°	-	-	-	-	
EL . 5 . 350 . 19	350	19°	44	-	23	-	
EL . 5 . 350 . 23	350	23°	52	-	24	-	
EL . 5 . 350 . 27	350	27°	66	-	30	-	
EL . 5 . 350 . 31	350	31°	71	-	33	-	

Aluminium impeller

5 blades

Serie LC.5 ...

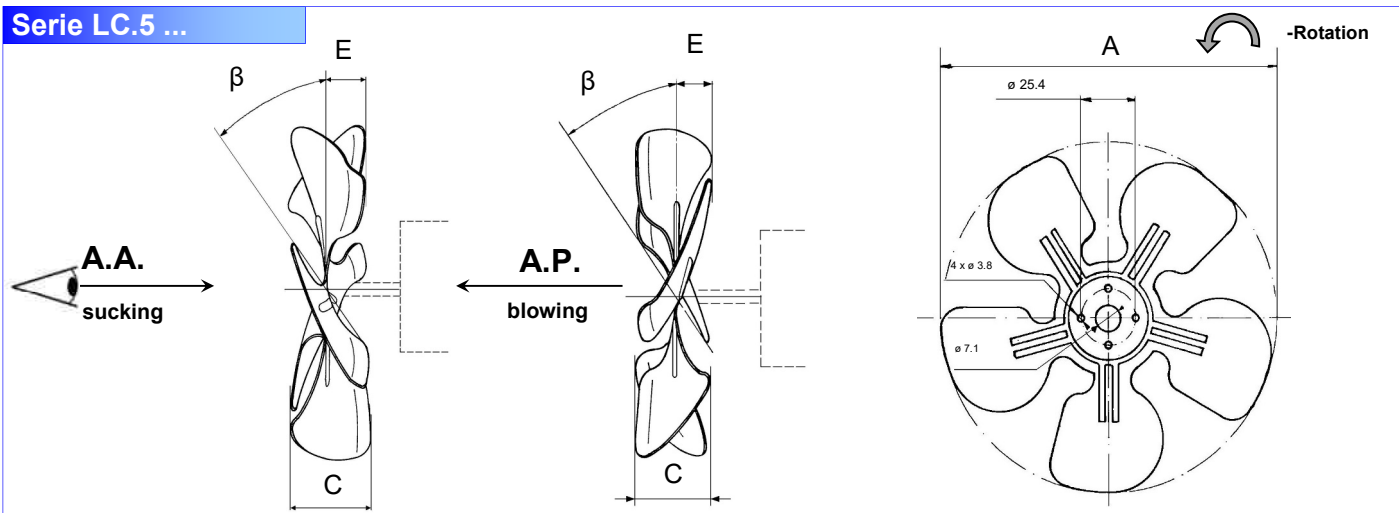

Serie LC.5 ...

CODE	Dimensions						Motors combination
	A	B	C ± 2mm		E ± 1.5mm		
	ø, mm	Incl, °	AA	AP.	AA	AP	
LC . 5 . 172 . 22	172	22°					See each motor version
LC . 5 . 172 . 28	172	28°	36		17		
LC . 5 . 172 . 34	172	34°	42		26		
LC . 5 . 200 . 22	200	22°					
LC . 5 . 200 . 28	200	28°	37		18		
LC . 5 . 200 . 34	200	34°	46		28		
LC . 5 . 254 . 22	254	22°					
LC . 5 . 254 . 28	254	28°	39		19		
LC . 5 . 254 . 34	254	34°	50		21		

Accessories

universal ECM motors 08-15-21

Staffe - Bracket - Support - Fuß

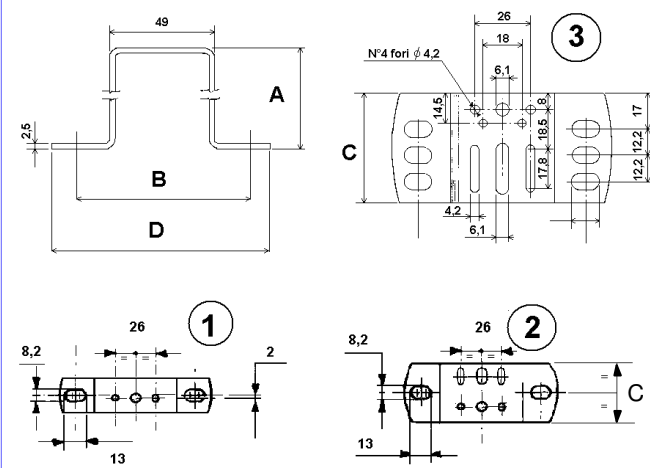

CODE	Dimensions				Pacco mm	Fig.
	A	B	C	D		
087.0119.0000	39	78	25	101	13/20	1
087.0102.0000	52	78	25	101	13/20	
087.0100.0000	71	78	25	101	13/20	
087.0101.0000	83	78	25	101	20/25	2
087.0116.0000	83	78	42	101	30	3
087.0120.0000	83	78	52	101	30/40/45	
087.0125.0000	108,5	78	52	101		3
087.0123.0000	55	130	25	153	13/20	1
087.0212.0000	72	133	25	156	13/20	
087.0211.0000	72	159	25	182	13/20	
087.0213.0000	110,5	154	52	177	30/40/45	3

Bocchigli - Ring - Virole - Ring

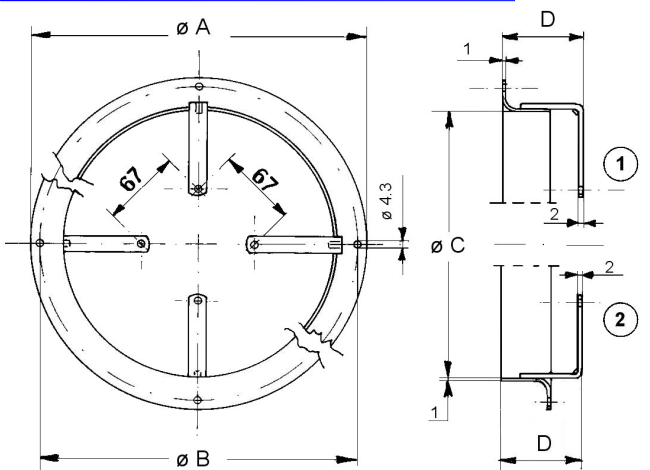

CODE	Dimensions				Impeller ø, mm	Fig.
	A	B	C	D		
079.0301.0000	200	190	162	46	154	1
079.0303.0000	222	208	180	46,5	172	
079.0305.0000	246	236	208	47	200	
079.0309.0000	276	266	238	51	230	
079.0308.0000	300	290	262	51	254	
079.0310.0000	356	344	308	51	300	2
079.0201.0000	200	190	162	46	154	
079.0203.0000	222	208	180	46,5	172	
079.0205.0000	246	236	208	46,5	200	
079.0212.0000	276	266	238	51	230	
079.0209.0000	300	290	262	51	254	
079.0210.0000	356	344	308	51	300	

Reti - Fanguard - Grille - Schutzgitter

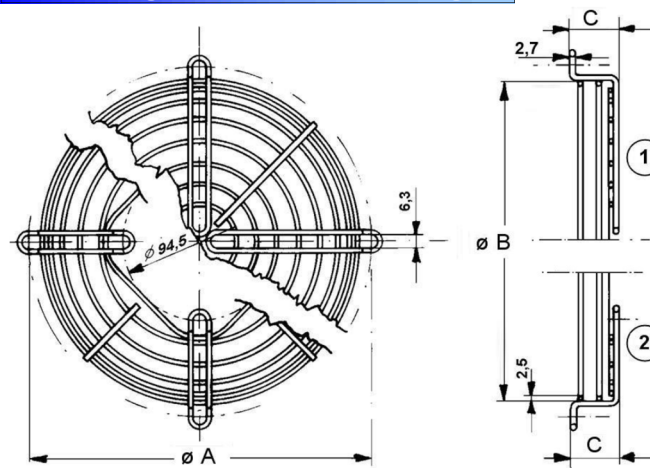

CODE	Dimensions			Impeller ø, mm	Fig.
	A	B	C		
036.0304.0000	208	188	26	172	1
036.0312.0000	236	226	26	200	
036.0300.0000	270	246	26	230	
036.0301.0000	290	267	36	254	
036.0412.0005	365	340	50	300	
036.0305.0000	208	188	26	172	2
036.0203.0000	236	223	26	200	
036.0200.0000	280	246	26	230	
036.0201.0000	289	266	26	254	
036.0201.0037	289	266	37	254	
036.0412.0000	365	340	47	300	
036.0354.0000	420	380	53	350	

Performances curves

1 speed ECM fans Ø154mm ÷ Ø230mm

08UA ... Ø154 1350rpm

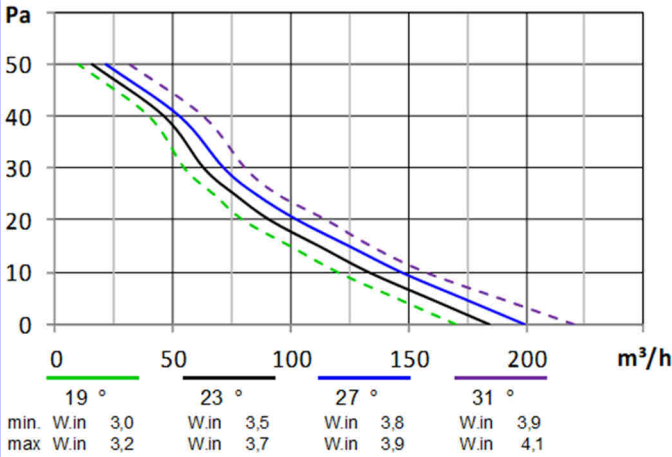

08UA ... Ø172 1350rpm

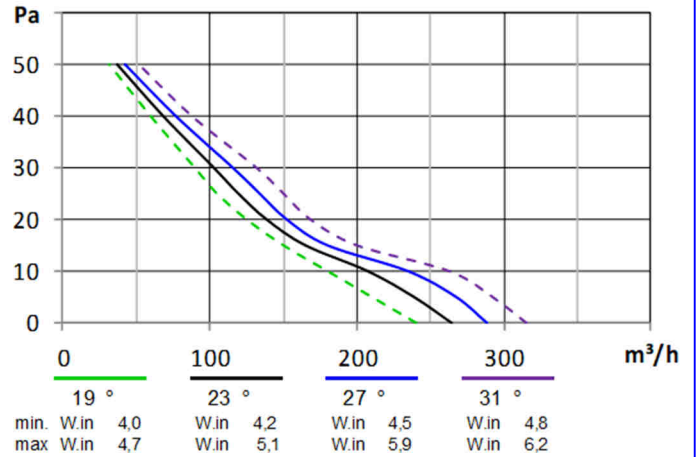

08UA ... Ø200 1350rpm

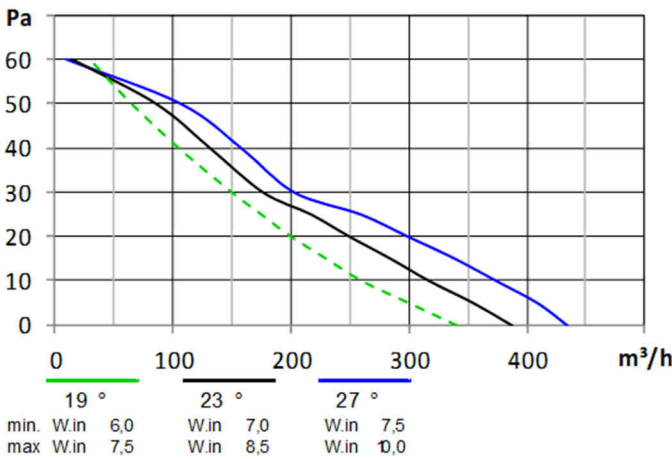

15UA ... Ø200 1350rpm

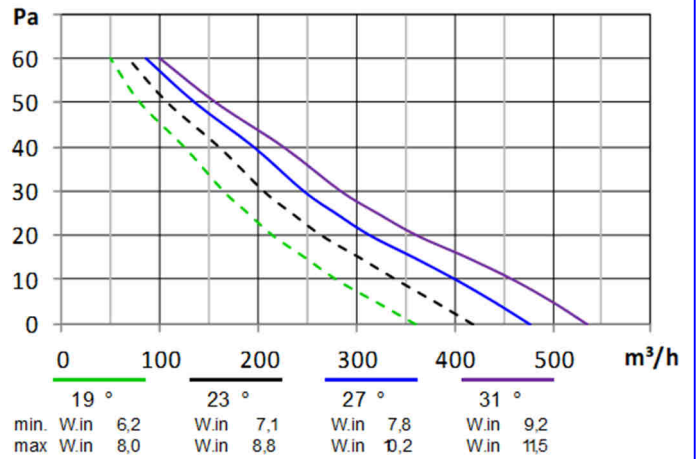

08UA ... Ø230 1350rpm

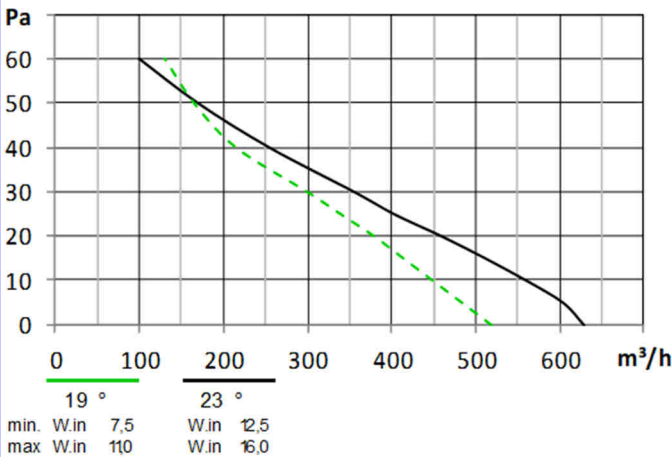

15UA ... Ø230 1350rpm

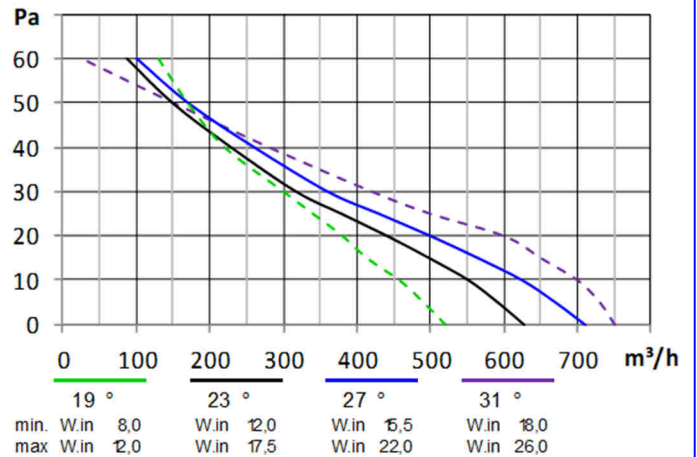

Performances curves

1 speed ECM fans Ø230mm ÷ Ø350mm

21UA ... Ø230 1350rpm

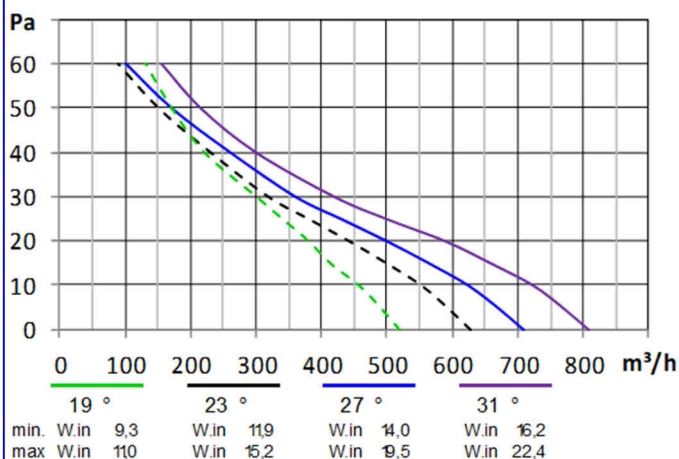

15UA ... Ø254 1350rpm

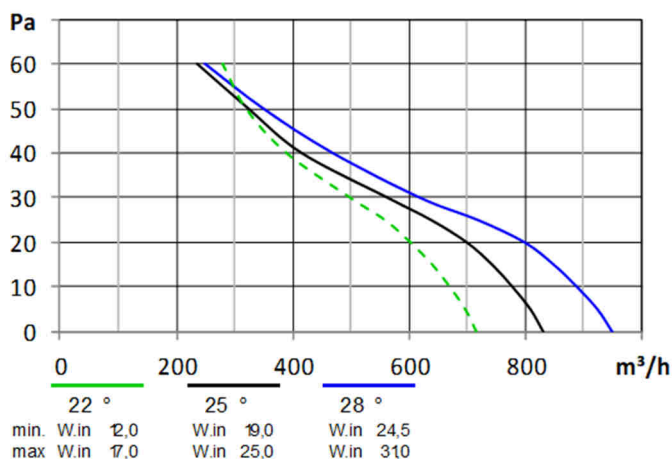

21UA ... Ø254 1350rpm

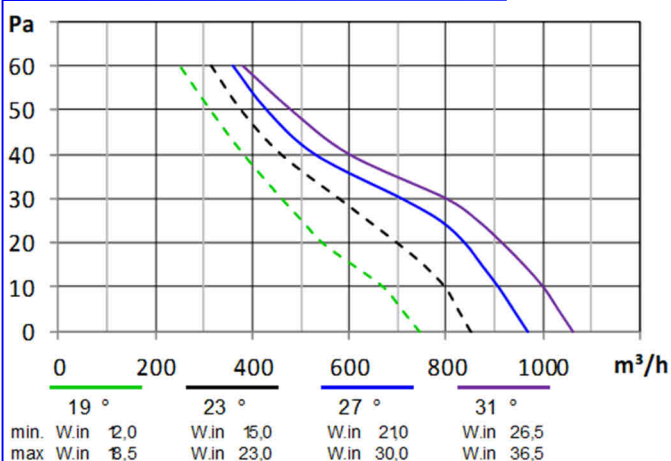

21UA ... Ø300 1350rpm

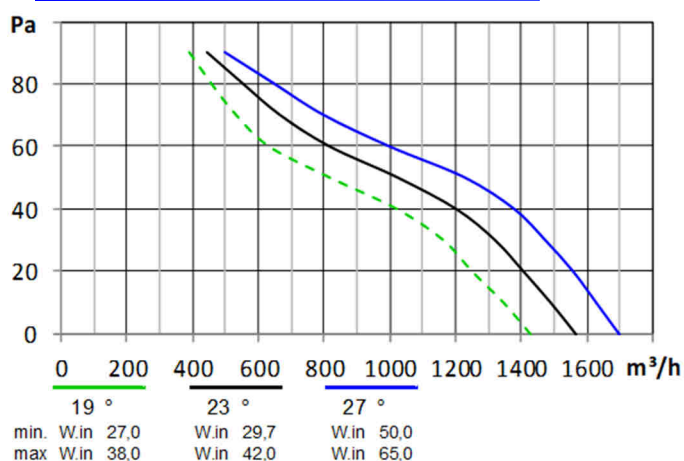

21UA ... Ø315 1350rpm

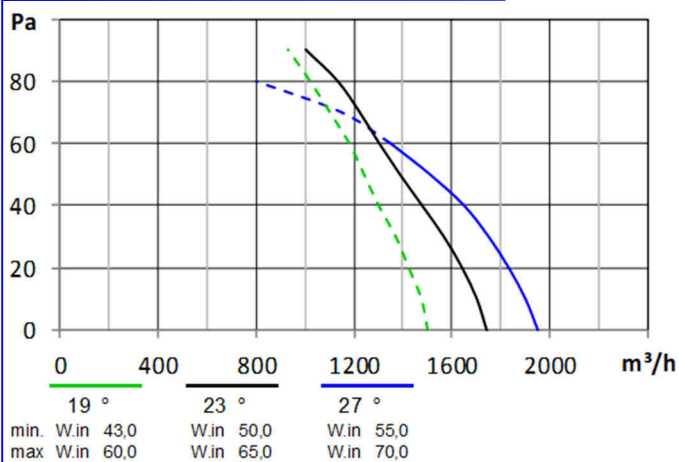

21UA ... Ø350 1350rpm

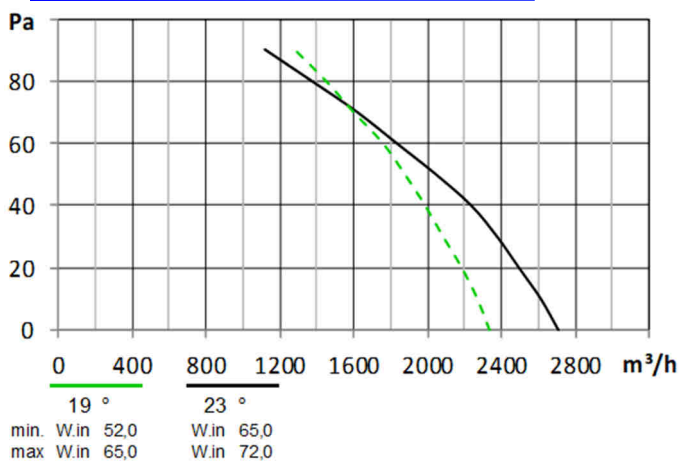

Performances curves

2 speed ECM fans Ø154mm ÷ Ø230mm

08UB.. Ø154-27° 1800-1350rpm

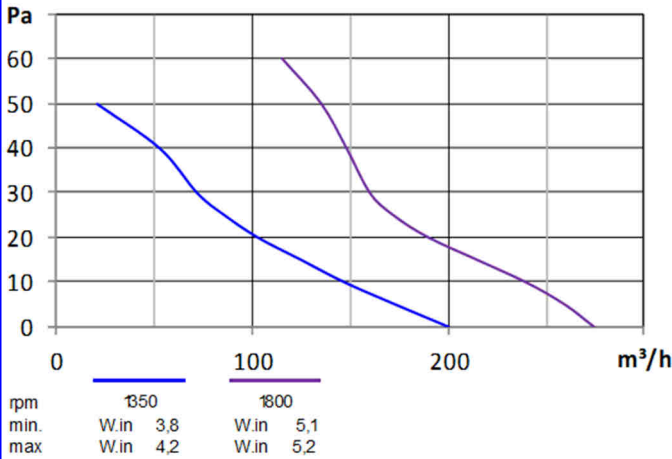

08UB.. Ø172-27° 1800-1350rpm

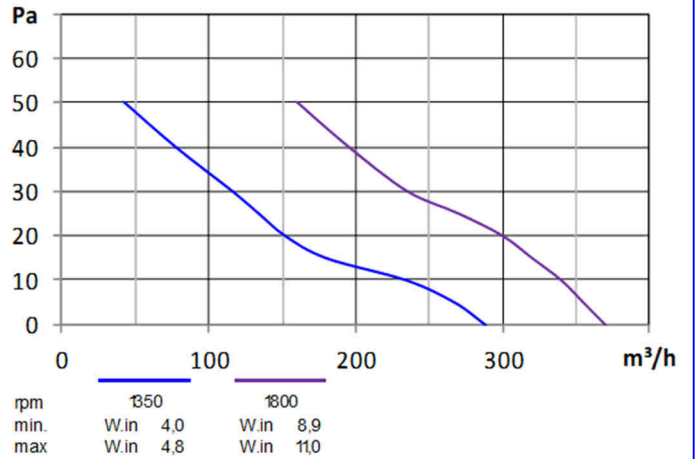

08UB.. Ø200-28° 1600-1350rpm

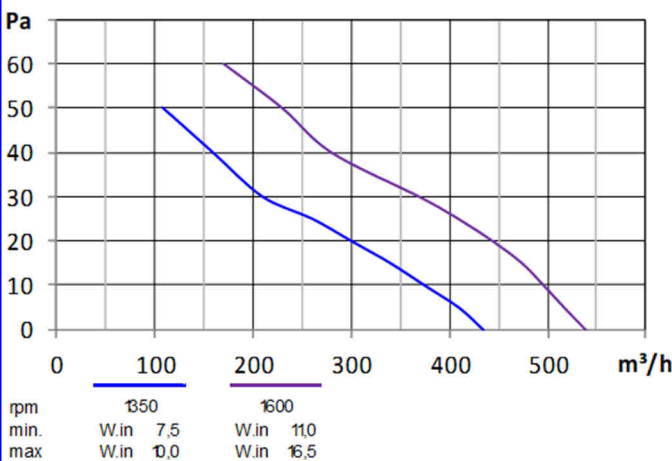

15UB.. Ø200-34° 2100-1500rpm

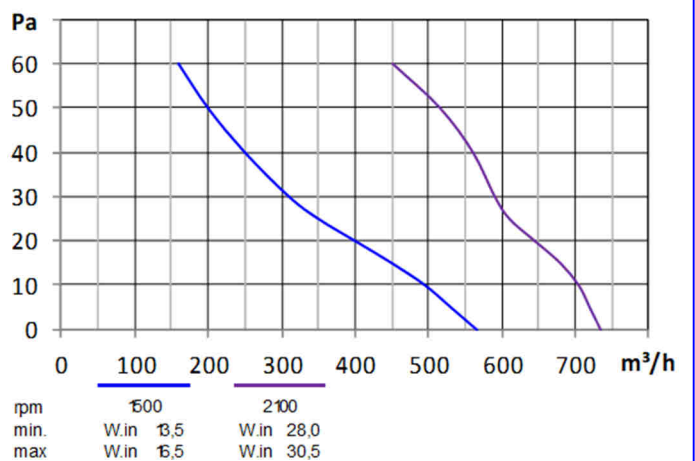

08UB.. Ø230-23° 1600-1350rpm

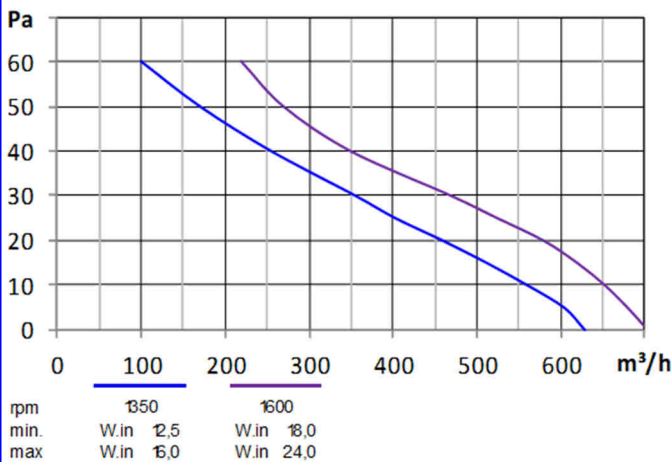

15UB.. Ø230-27° 1600-1350rpm

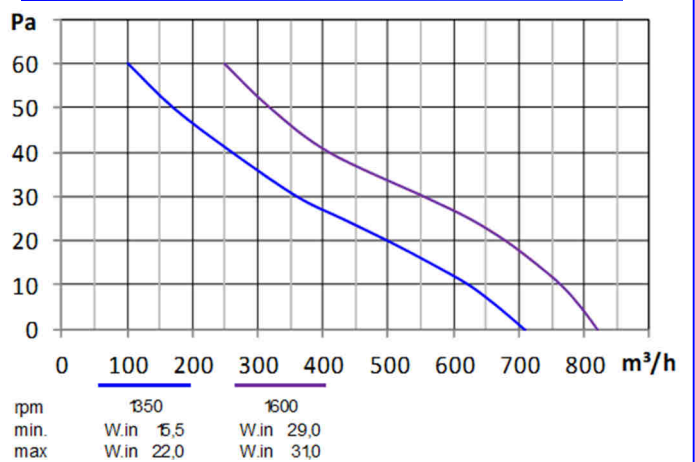

Performances curves

2 speed ECM fans Ø230mm ÷ Ø350mm

21UB.. Ø230-31° 1600-1350rpm

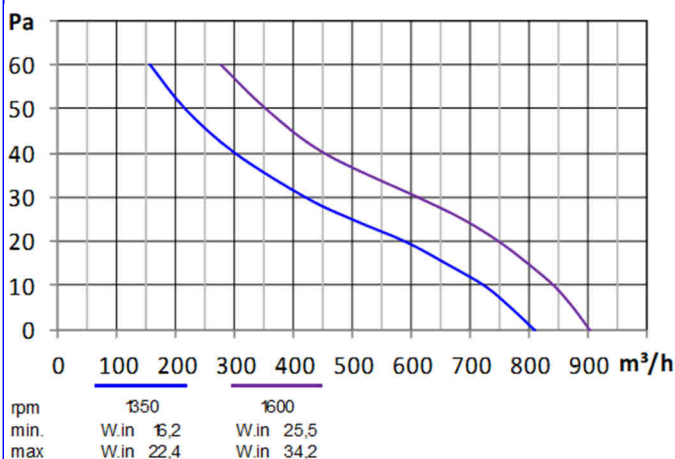

15UB.. Ø254-19° 1600-1350rpm

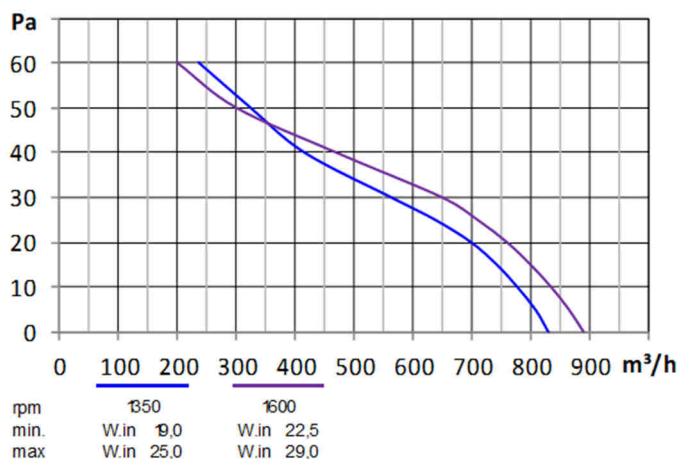

21UB.. Ø254-34° 1600-1350rpm

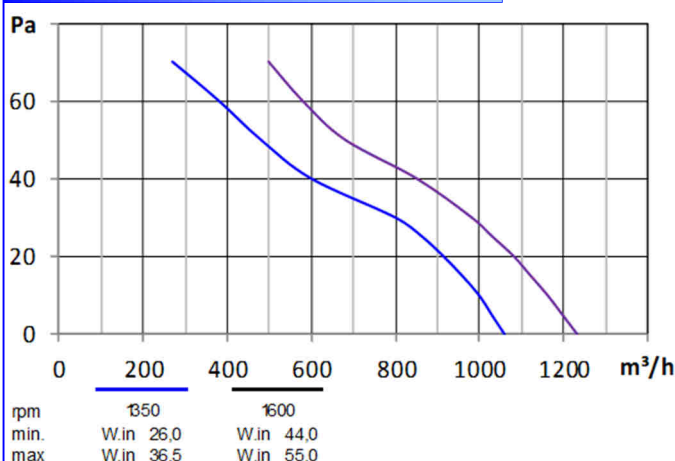

21UB.. Ø300-27° 1350-1000rpm

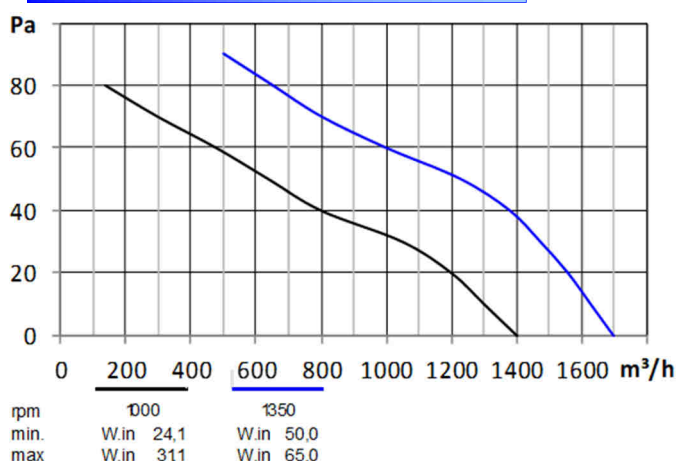

21UB.. Ø315-27° 1350-1000rpm

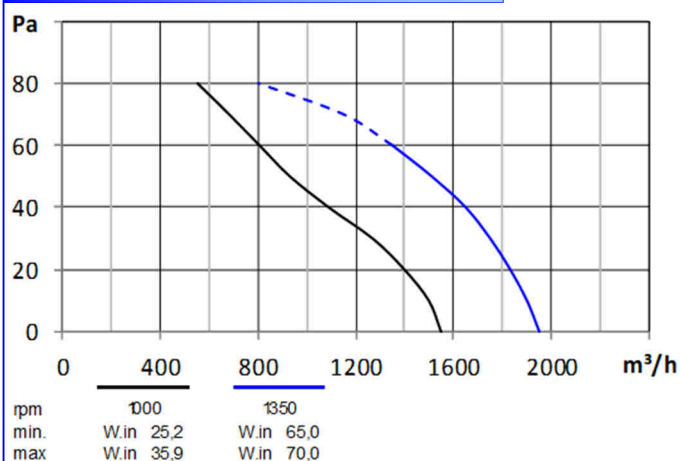

21UB.. Ø350-23° 1350-1000rpm

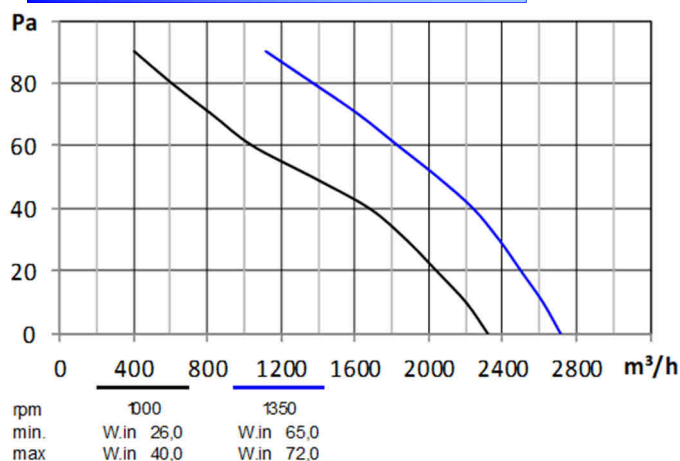

Performances curves

0-10 variable speed ECM fans Ø154 ÷ Ø230mm

08UC.. Ø154-27° 2500 ÷ 800rpm

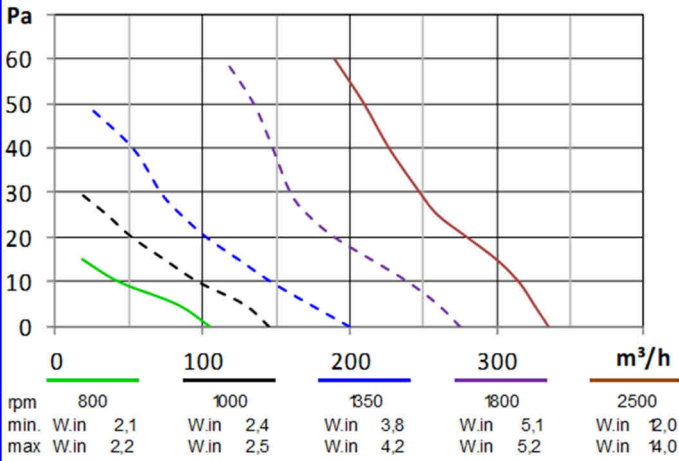

08UC.. Ø172-27° 2200 ÷ 800rpm

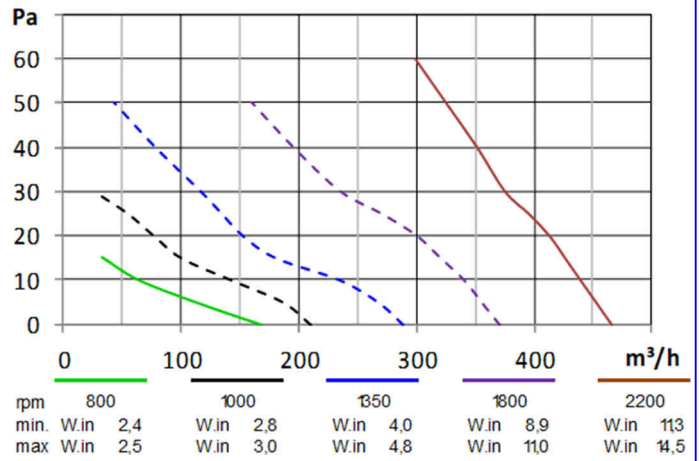

08UC.. Ø200-28° 1800 ÷ 800rpm

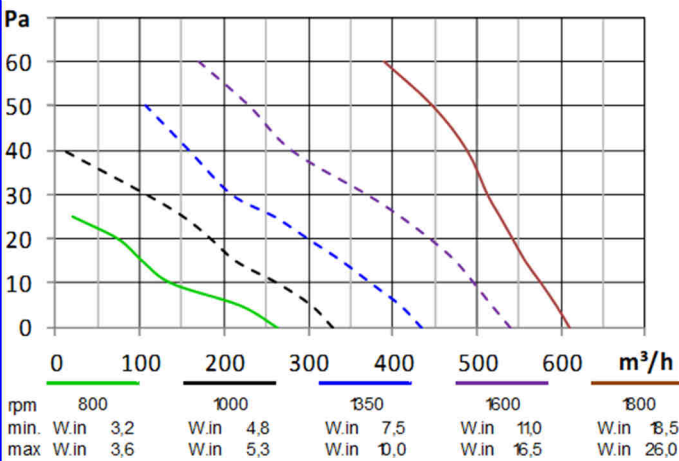

15UC.. Ø200-34° 2100 ÷ 800rpm

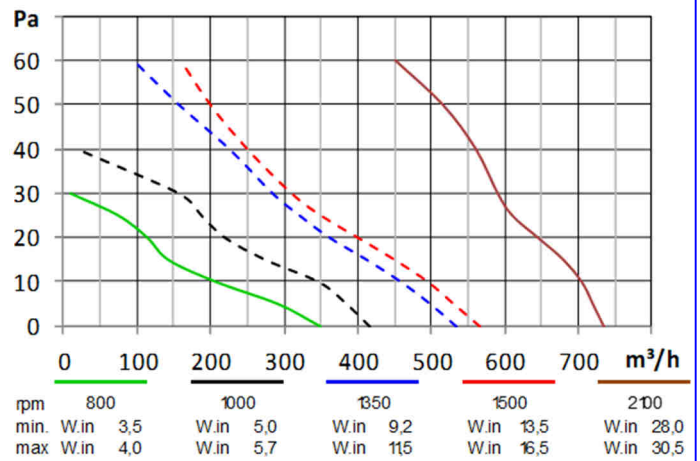

08UC.. Ø230-23° 1600 ÷ 800rpm

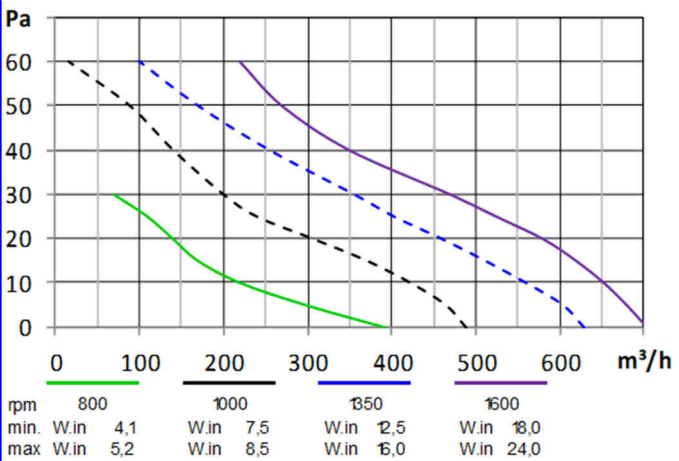

15UC.. Ø230-27° 1600 ÷ 800rpm

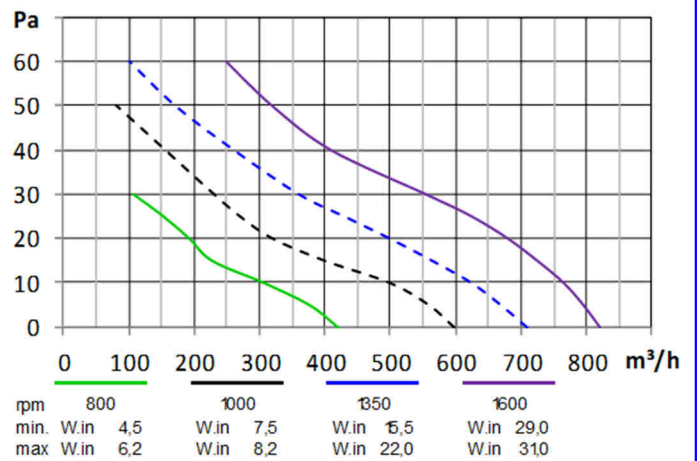

Performances curves

0-10 variable speed ECM fans Ø230 ÷ Ø350mm

21UC.. Ø230-31° 1800 ÷ 800rpm

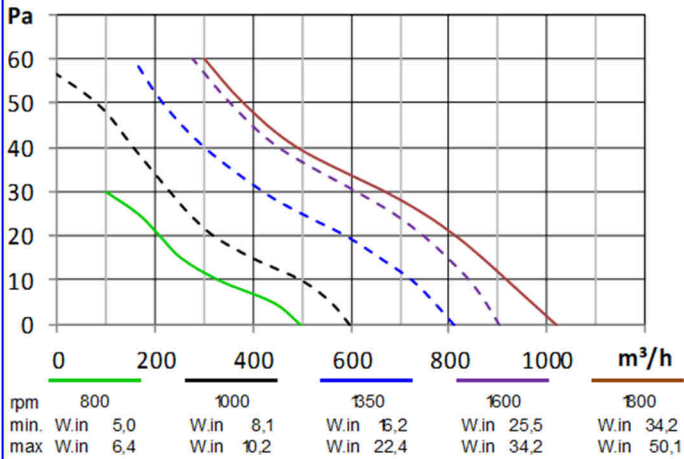

15UC.. Ø254-19° 1600 ÷ 800rpm

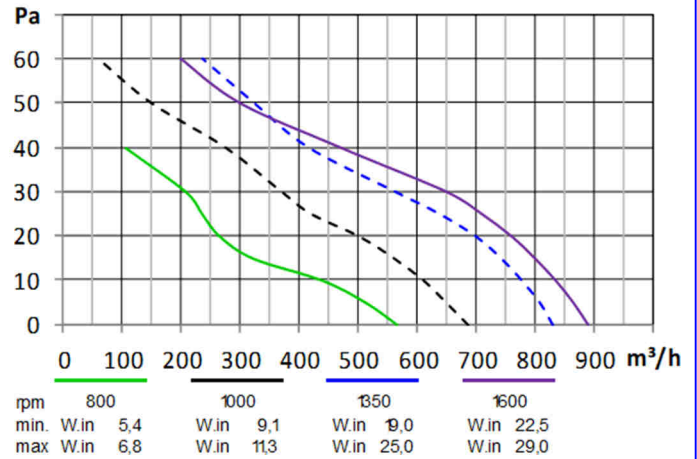

21UC.. Ø254-34° 1600 ÷ 800rpm

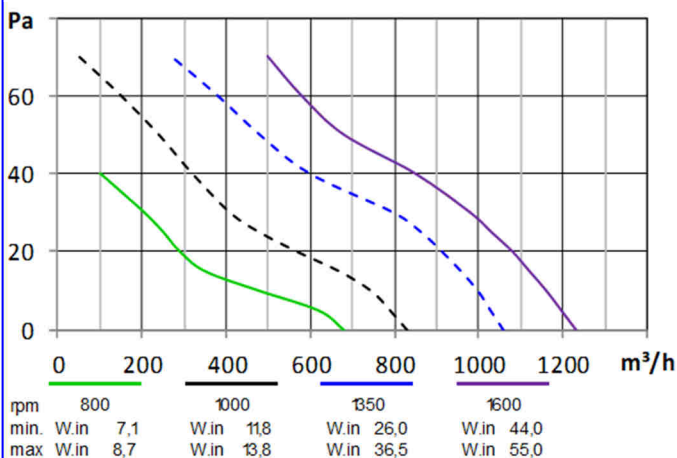

21UC.. Ø300-27° 1350 ÷ 800rpm

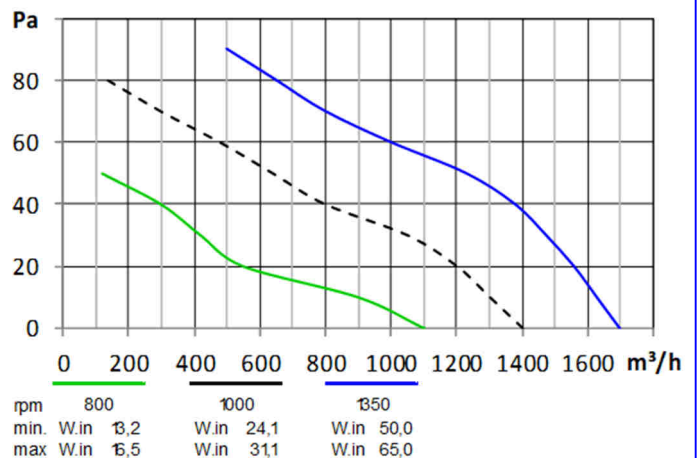

21UC.. Ø315-27° 1350 ÷ 800rpm

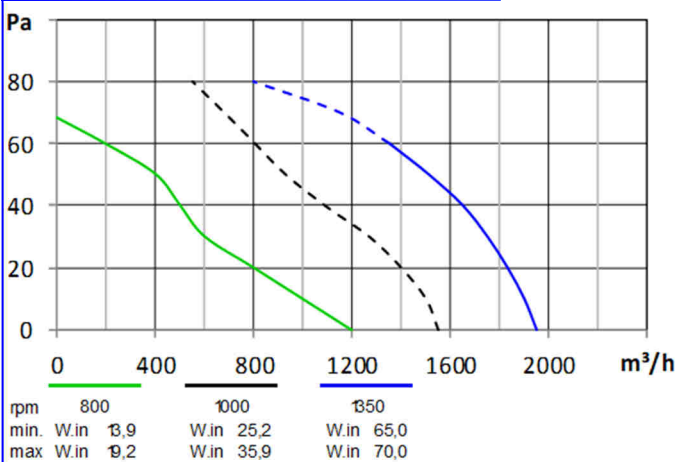

21UC.. Ø350-23° 1350 ÷ 800rpm

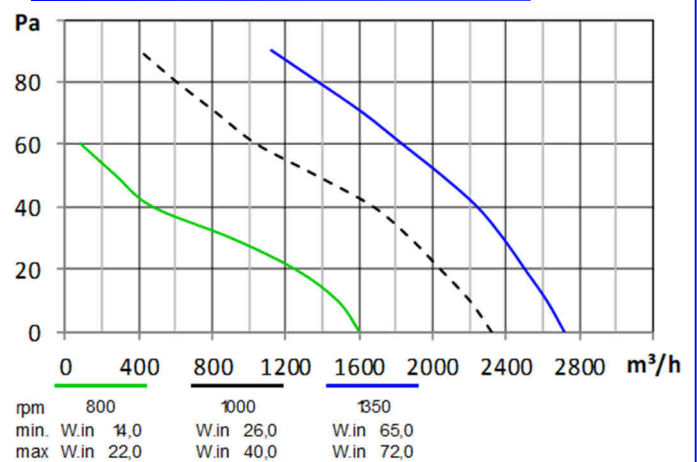

ECM electric connection

UA - UB - UC

Serie UA - 1 speed

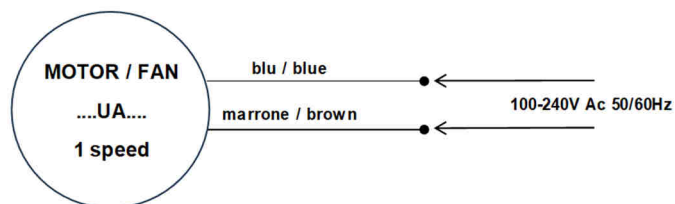

Serie UB - 2 speed or reverse

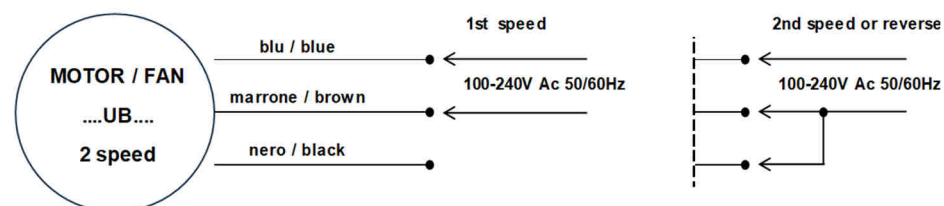

Serie UC - variable speed

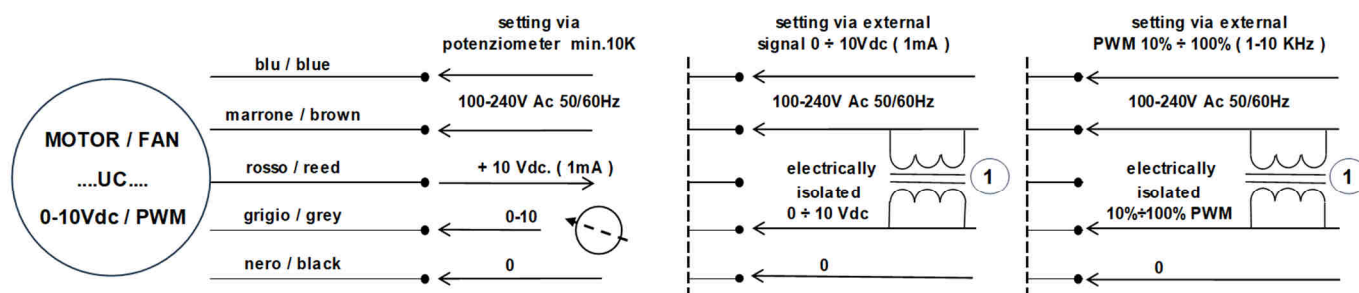

① on demand OPTO-ISOLATOR cod. 131.0372.0000